

Pictures and part numbers

Series 100/2400

- Std. material grey Acetal
- 4"/102mm wide
- 16 fingers
- 2 nylon shoulder bolts M6-1/4" included (For loose parts:
Imperial ▶ A6H7A1XXC3MS-00
Metric ▶ A6H7M1XXT1MG-00)

Part number:

- A4D1R2XXXFLS-01
- Stock Europe
- Stock US

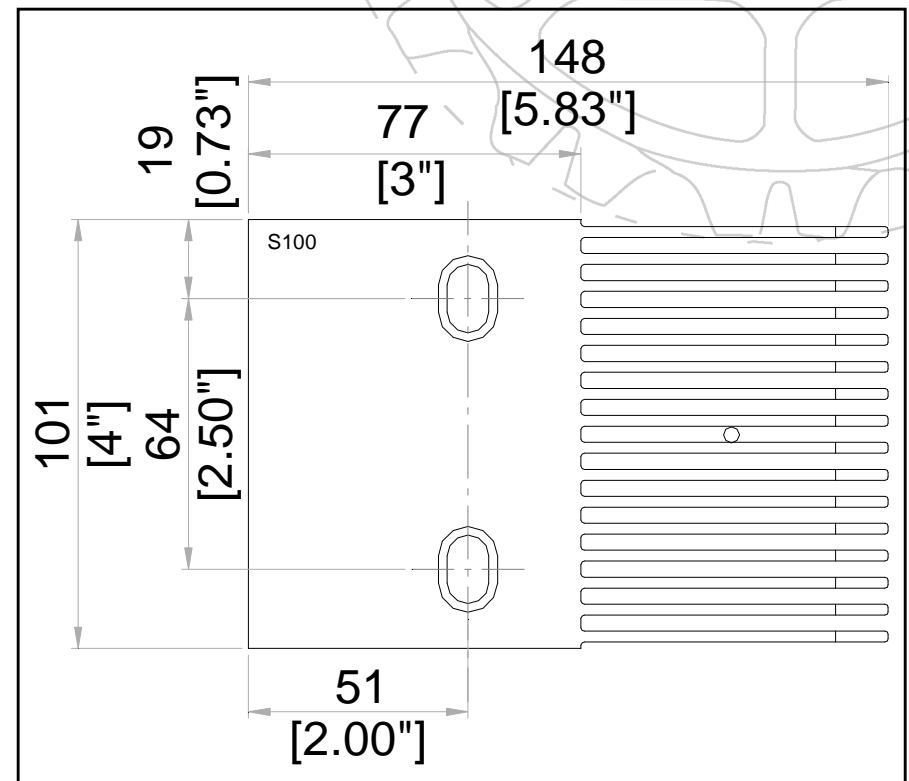
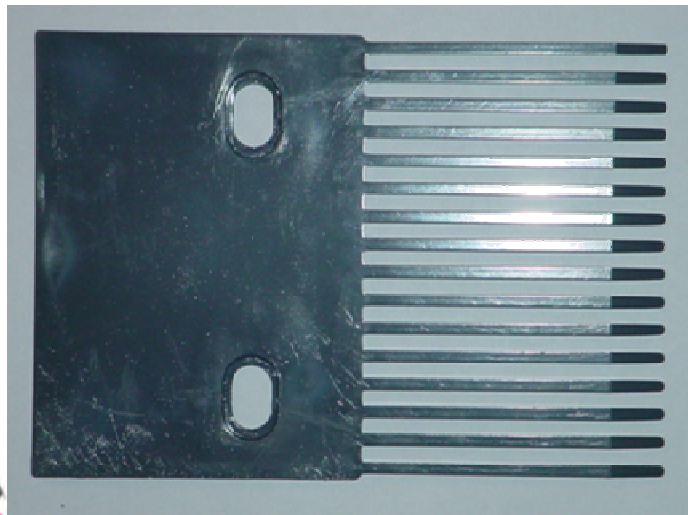

Series 100/2400 REXAM

- Std. material grey Acetal
- 4"/102mm wide
- 16 fingers
- 2 nylon shoulder bolts M6-1/4" included (For loose parts:
Imperial ▶ A6H7A1XXC3MS-00
Metric ▶ A6H7M1XXT1MG-00)

Part number:

- A4D1R1XXXFLS-01
- Europe lead time: 30 days
- Stock US

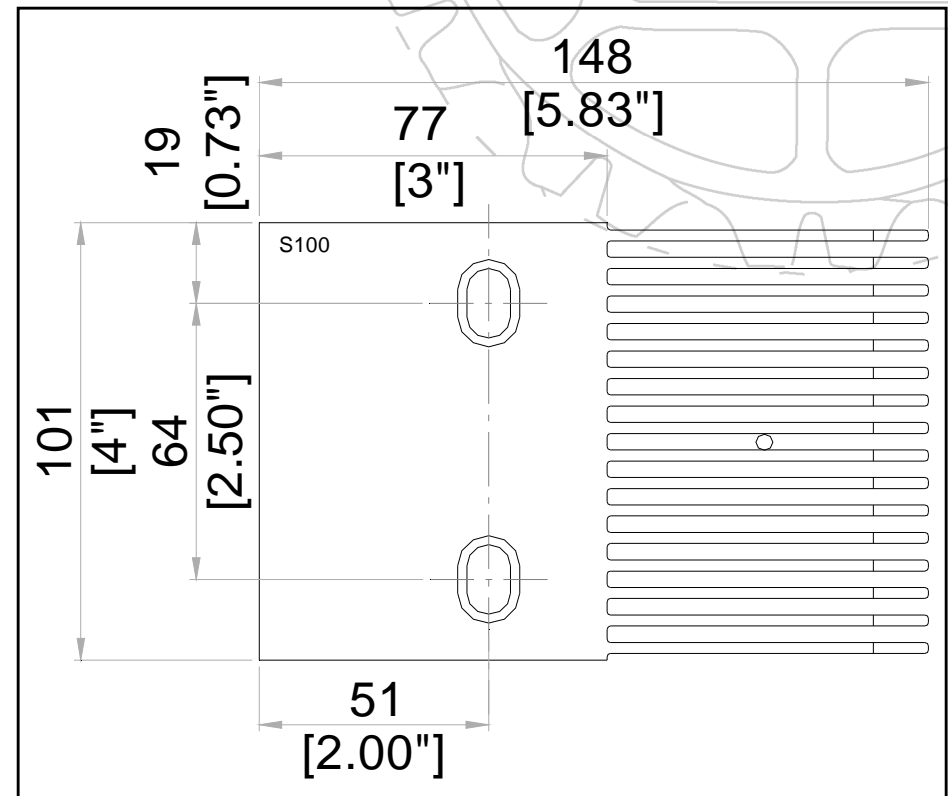
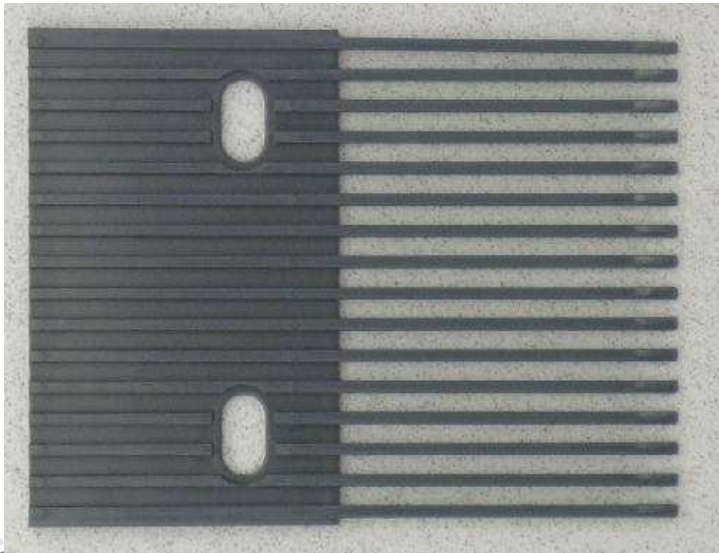

Series 200

We don't have the Series 200 Raised Rib belt anymore in our program (for more than 10 years).

Can only be ordered for replacement.

- Std. material grey Polypropylene
- 7.2"/183mm wide
- 10 fingers
- 2 nylon shoulder bolts M6-1/4" included (For loose parts:
Imperial ▶ A6H7A1XXC3MS-00
Metric ▶ A6H7M1XXT1MG-00)

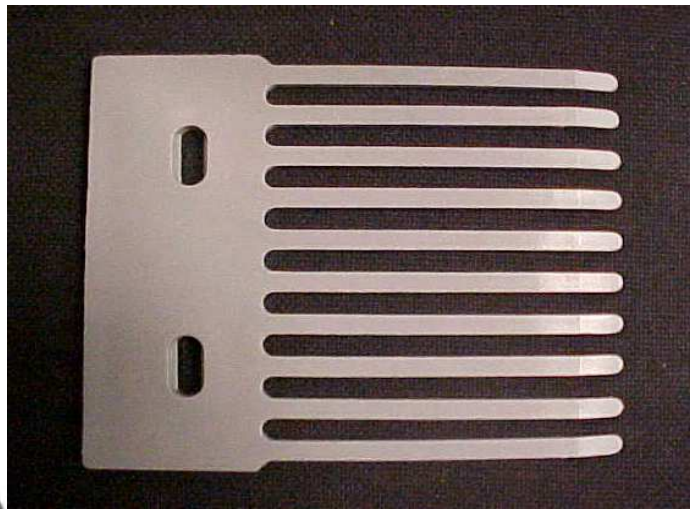

Part number:

- A4D2R2XXXFLB-00
- Europe lead time: 30 days
- Stock US

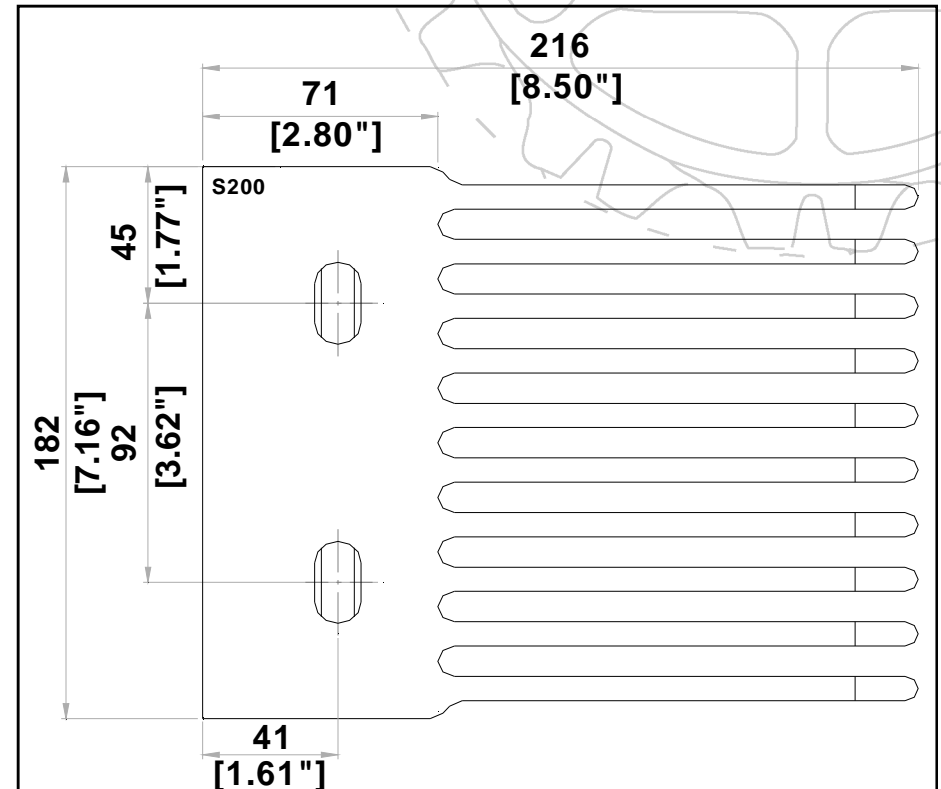



Series 400 / 1200 / 800

Two material glass handling

- 6"/152mm wide
- 18 fingers
- short finger/short back
- grey part is Acetal
- white part is Glass filled polyurethane

Enter separate line item for necessary hardware (consists of 2 bolts, 2 washers and 2 snap caps).

- B4D4MBXXXMT-00 (Metric)
- B4D4IBXXXMT-00 (Imperial)



Part number:

- A4D4R8XXXFNK-00
- Stock Europe
- US lead time: 3 days

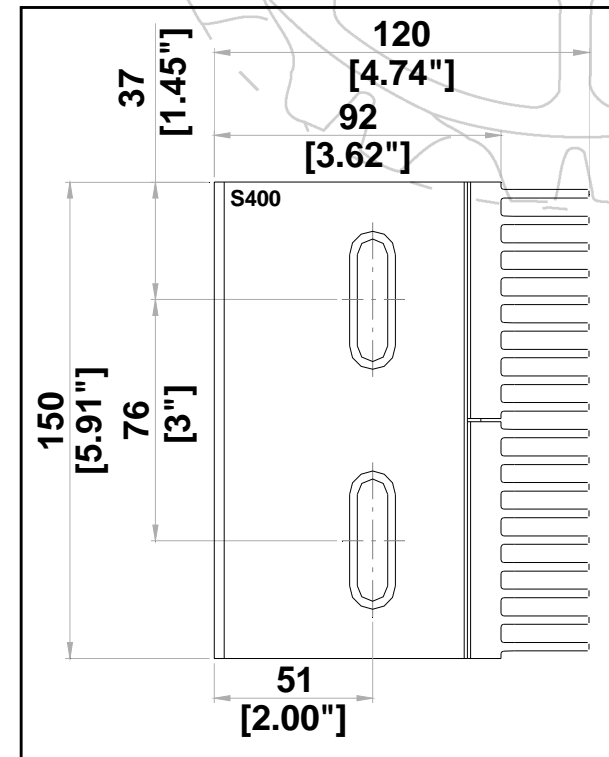



Series 400 / 1200 / 800

Two material glass handling

- 6"/152mm wide
- 18 fingers
- short finger/long back
- grey part is Acetal
- white part is Glass filled polyurethane

Enter separate line item for necessary hardware (consists of 3 bolts, 3 washers and 3 snap caps).

- B4D4MAXXXMT-30 (Metric)
- B4D4IAXXXMT-30 (Imperial)



Part number:

- A4D4R7XXXFNK-11
- Stock Europe
- Stock US

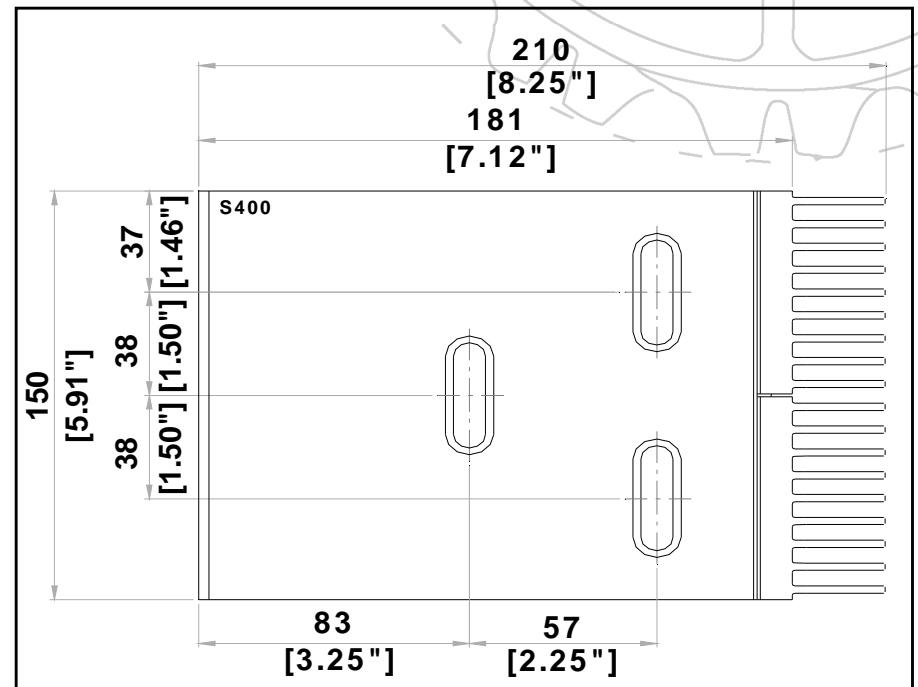

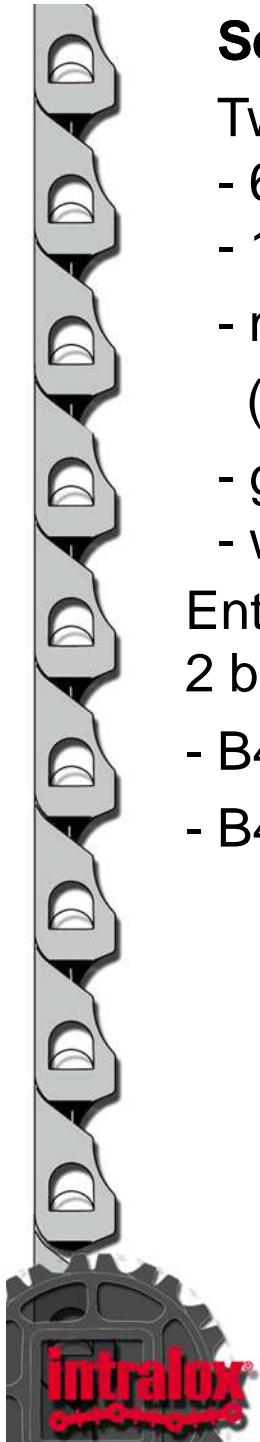

Series 400 / 1200 / 800

Two material glass handling

- 6"/152mm wide
- 18 fingers
- medium finger/short back
(extended fingers/short back)
- grey part is Acetal
- white part is Glass filled polyurethane

Enter separate line item for necessary hardware (consists of 2 bolts, 2 washers and 2 snap caps).

- B4D4MBXXXMT-00 (Metric)
- B4D4IBXXXMT-00 (Imperial)



Part number:

- A4D4R9XXXFNK-01
- Stock Europe
- US lead time: 3 days

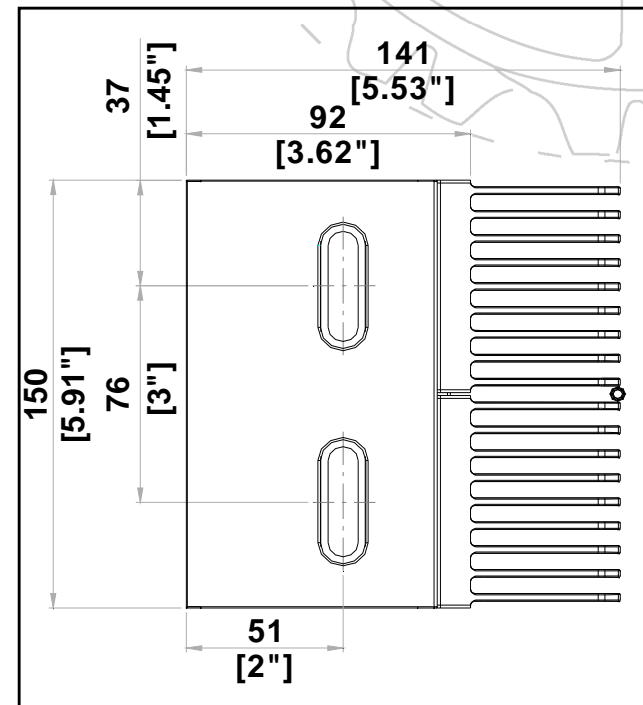

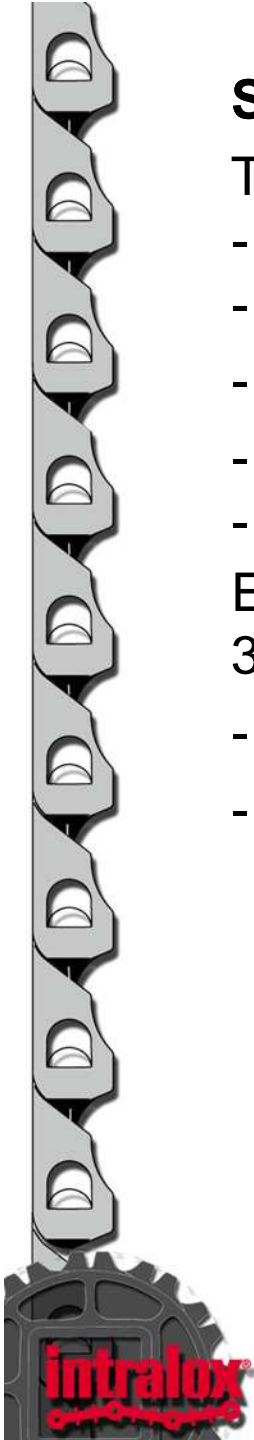

Series 400 / 1200 / 800

Two material glass handling

- 6"/152mm wide
- 18 fingers
- medium finger/long back
- grey part is Acetal
- white part is Glass filled polyurethane

Enter separate line item for necessary hardware (consists of 3 bolts, 3 washers and 3 snap caps).

- B4D4MAXXXMT-30 (Metric)
- B4D4IAXXXMT-30 (Imperial)



Part number:

- A4D4R0XXXFNK-01
- Stock Europe
- Stock US

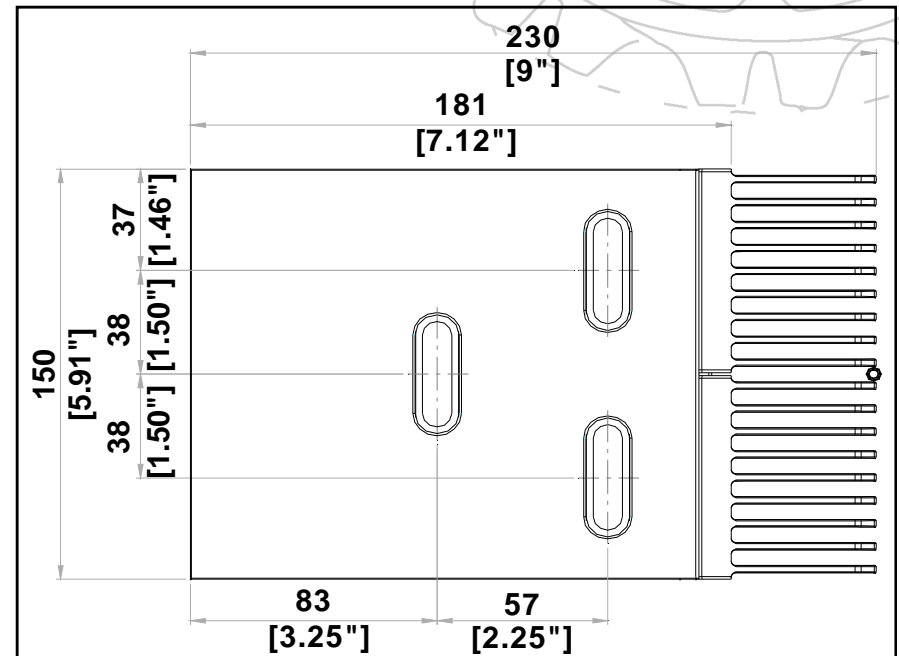

Series 400 / 1200 / 800

Two material FTP

- 6"/152mm wide
- 18 fingers
- long finger / short back
- grey part is Acetal
- white part is Glass filled polyurethane
- 2 nylon shoulder bolts M6-1/4" included (For loose parts: Imperial ▶ A6H7A1XXC3MS-00 Metric ▶ A6H7M1XXT1MG-00)
- 2 snap caps included (For loose parts: A7D4BXXXXXLS-01)

Part number:

- A4D4R5XXXFNK-21
- Stock Europe
- Stock US

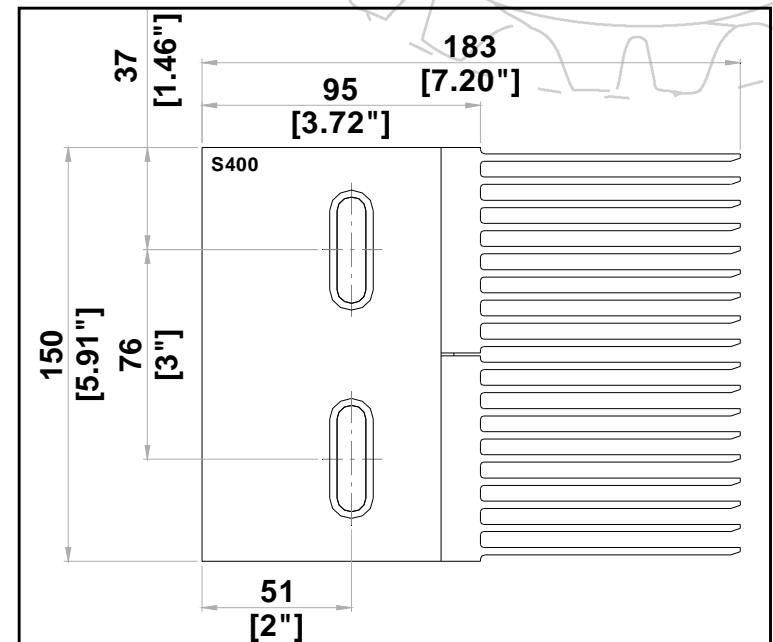

Series 400 / 1200 / 800

Two material FTP

- 6"/152mm wide
- 18 fingers
- long finger / long back
- grey part is Acetal
- white part is Glass filled polyurethane
- 3 nylon shoulder bolts M6-1/4" included (For loose parts: Imperial ▶ A6H7A1XXC3MS-00 Metric ▶ A6H7M1XXT1MG-00)
- 3 snap caps included (For loose parts: A7D4BXXXXXLS-01)



Part number:

- A4D4R6XXXFNK-11
- Stock Europe
- Stock US

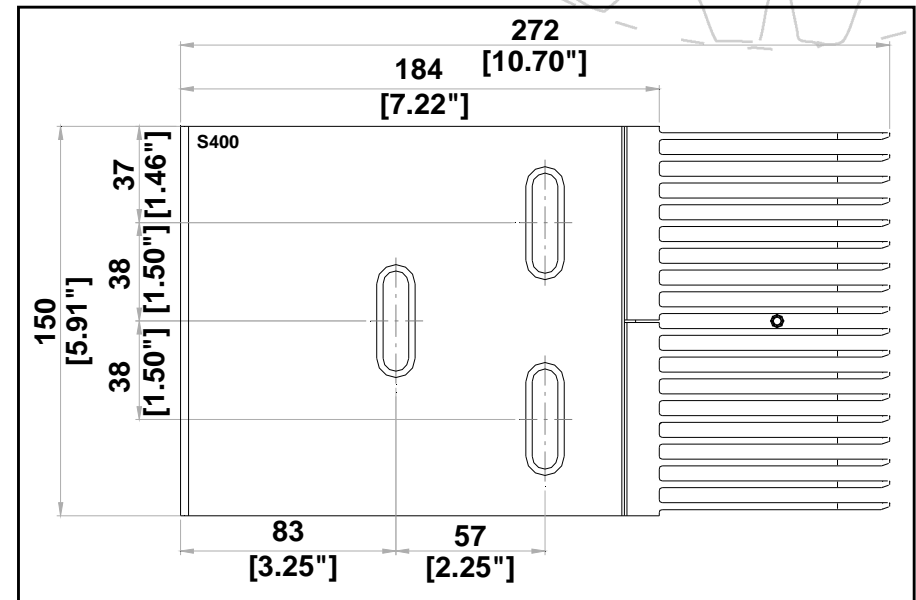

Series 400 / 1200

Black Glass filled Nylon

- 6"/152mm wide
- 18 fingers
- long finger / short back
- nylon shoulder bolts M6-1/2"
- snap caps
- Old version FTP
- Use only for replacement

Part number:

- A4D4R2XXFMD

Recommend S400/1200/800
two material FTP.

Part.nr:

A4D4R5XXFNK-21

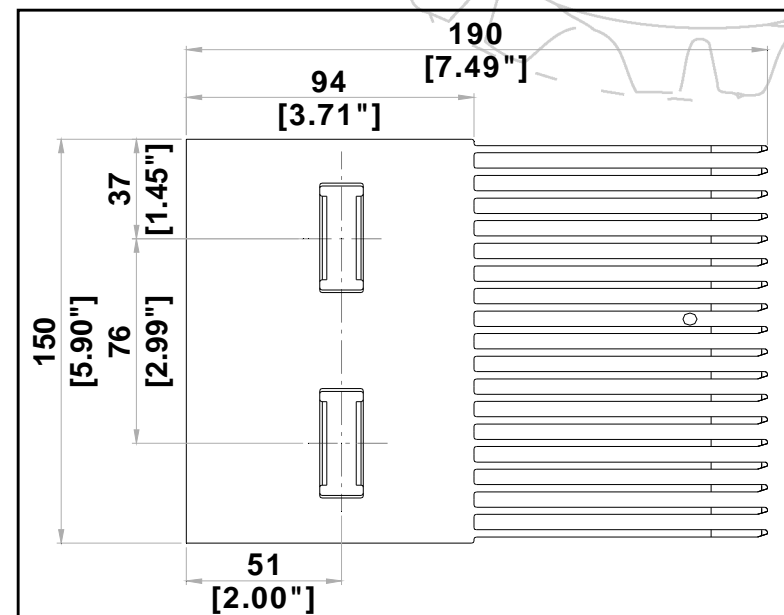
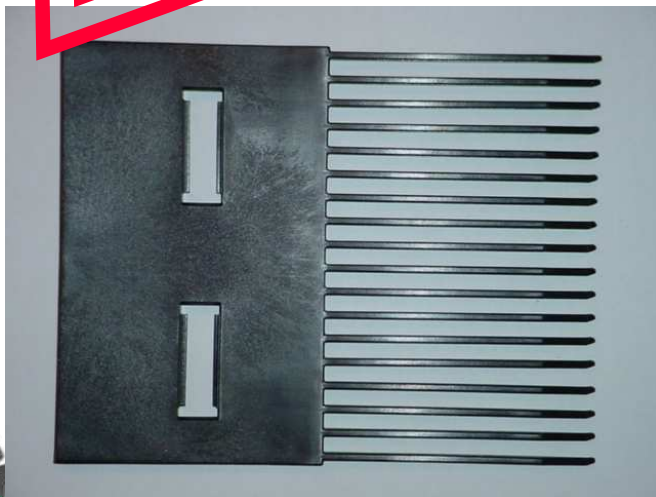

Series 400 / 1200 / 800

Blue Polypropylene

- 6"/152mm wide

- 18 fingers

- long finger / short back

- 2 nylon shoulder bolts M6-1/4"

included (For loose parts:

Imperial ▶ A6H7A1XXC3MS-00

Metric ▶ A6H7M1XXT1MG-00)

- 2 snap caps included (For loose parts: A7D4XXXXXXLS-00)

Part number:

- A4D4R2XXXFLE-00

- Stock Europe

- Stock US

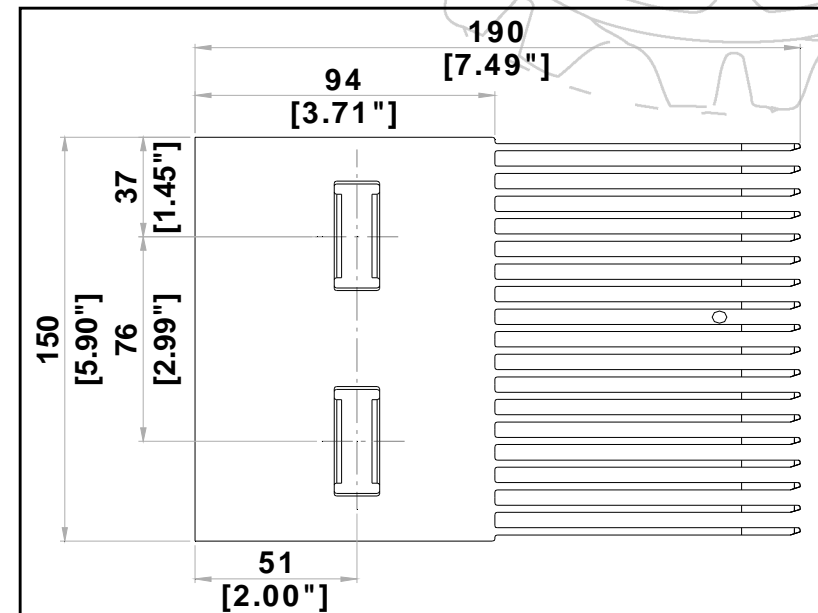
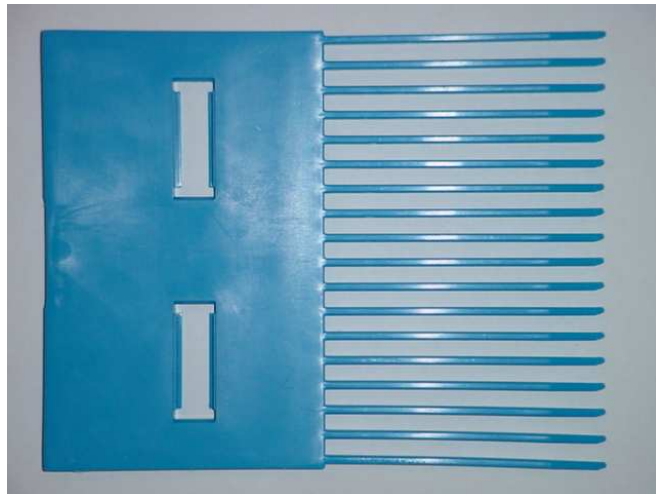



Series 400 / 1200 / 800

Two material FTP with 1.5"/38.1mm modified back plate & accessories

- long finger / short back
- 2 nylon shoulder bolts M6-1/4" included (For loose parts: Imperial ▶ A6H7A1XXC3MS-00 Metric ▶ A6H7M1XXT1MG-00)
- 2 snap caps included (For loose parts: A7D4BXXXXXLS-01)

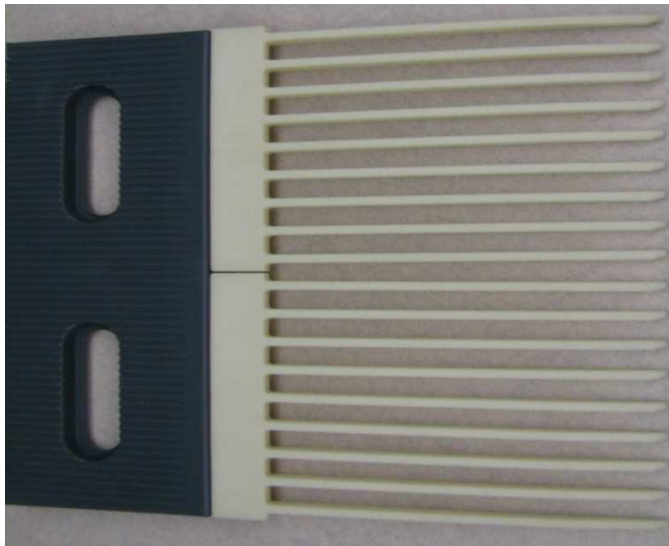

Part number:

- A4D4S3XXXFNK-00
- Europe lead time: 40 days
- US lead time: 10 days

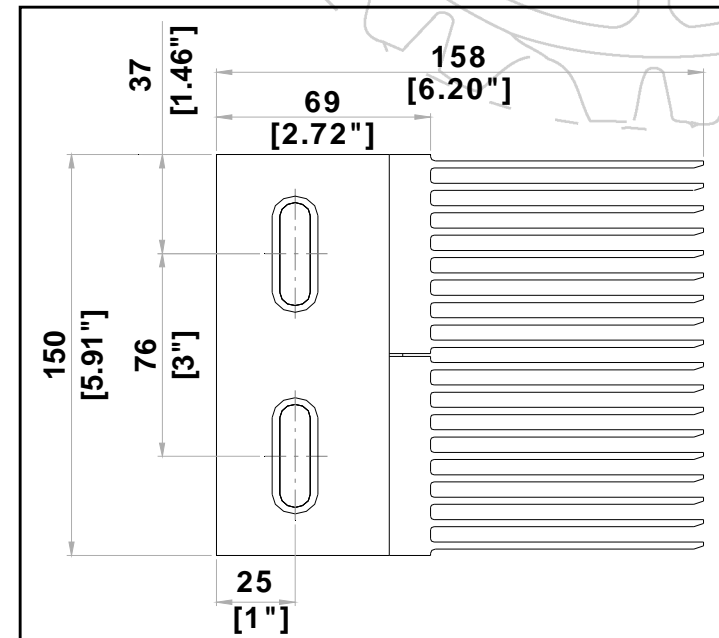



Series 400 / 1200 / 800

Two material FTP with 1"/25.4mm modified back plate & accessories

- long finger / short back
- 2 nylon shoulder bolts M6-1/4" included (For loose parts: Imperial ▶ A6H7A1XXC3MS-00 Metric ▶ A6H7M1XXT1MG-00)
- 2 snap caps included (For loose parts: A7D4BXXXXXLS-01)

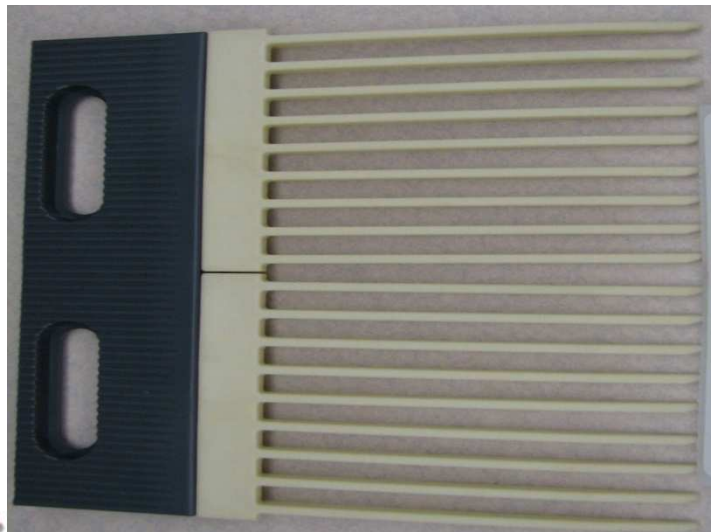

Part number:

- A4D4S4XXXFNK-00
- Europe lead time: 40 days
- US lead time: 10 days

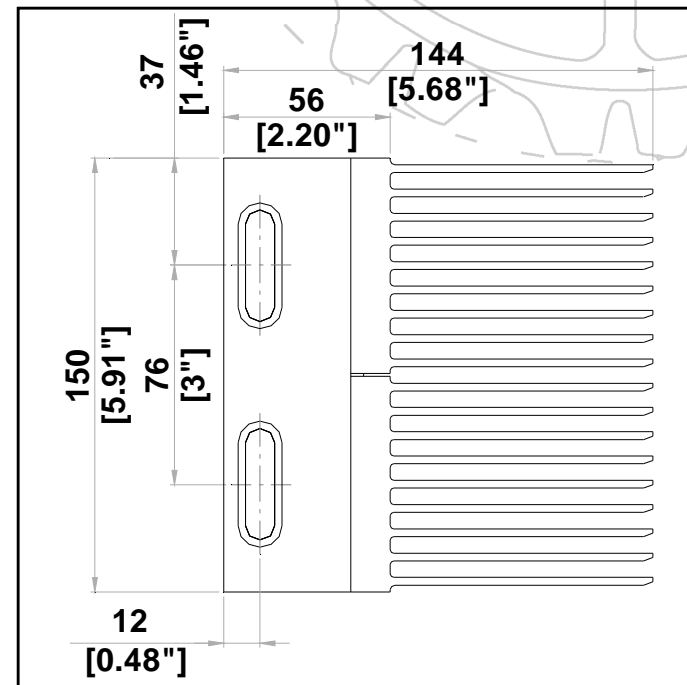

Series 400 / 1200 / 800

Two material FTP with
1"/25.4mm modified back plate
& accessories

- 6"/152mm wide
- mid-length finger / short back

Enter separate line item for necessary hardware (consists of
2 bolts, 2 washers and 2 snap caps).

- B4D4MBXXXMT-00 (Metric)
- B4D4IBXXXMT-00 (Imperial)

Part number:

- A4D4S5XXXFNK-00
- Europe lead time: 40 days
- US lead time: 10 days

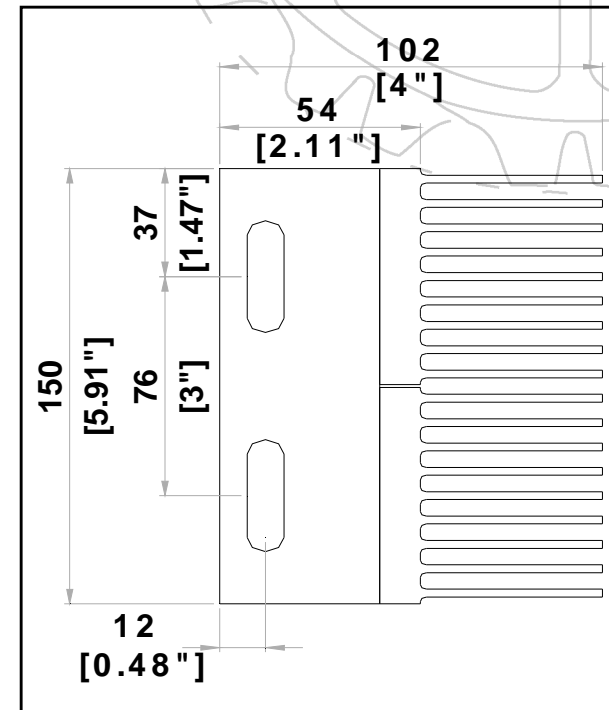



Series 900

Grey acetal with snap caps.

- 6"/152mm wide
- 18 fingers.
- 2 nylon shoulder bolts M6-1/4" included (For loose parts: Imperial ▶ A6H7A1XXC3MS-00 Metric ▶ A6H7M1XXT1MG-00)
- 2 snap caps included (For loose parts: A7D9XXXXXXLS-01)

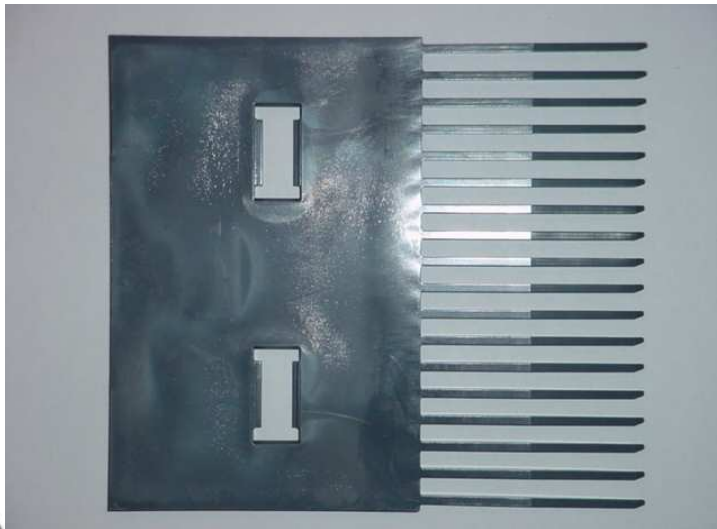

Part number:

- A4F4R2XXXFLS-01
- Stock Europe
- Stock US

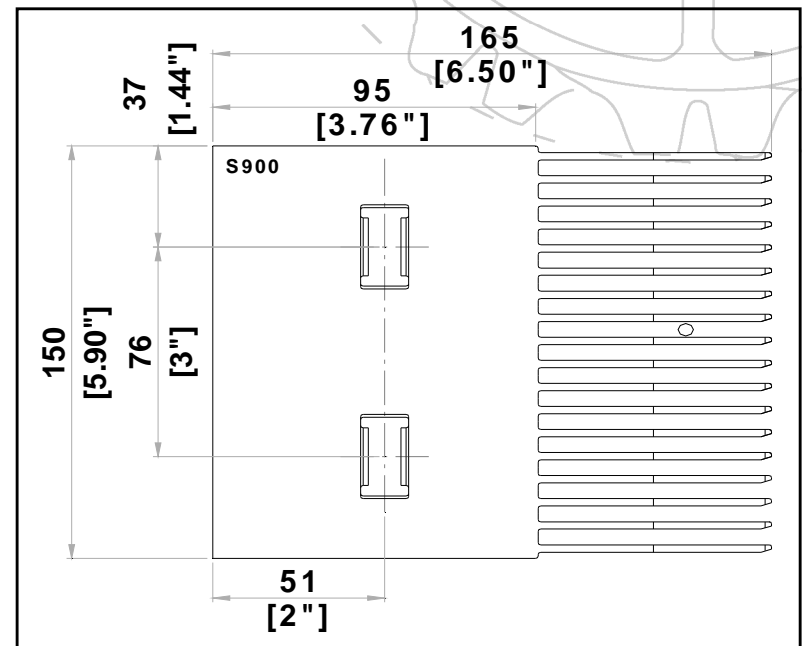

Series 900

Grey acetal with snap caps.

- 4"/100mm wide
- 12 fingers
- 2 nylon shoulder bolts M6-1/4" included (For loose parts: Imperial ▶ A6H7A1XXC3MS-00 Metric ▶ A6H7M1XXT1MG-00)
- 2 snap caps included (For loose parts: A7D9XXXXXXLS-01)
- Use this one only for retrofit from series 100.

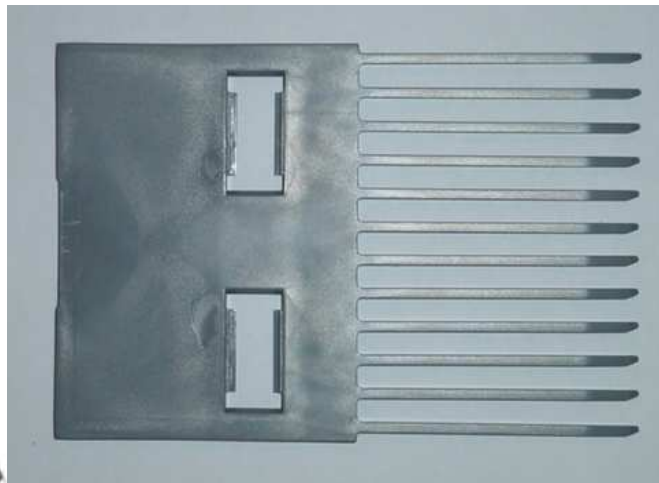

Part number:

- A4D9R3XXXFLS-01
- Stock Europe
- Stock US

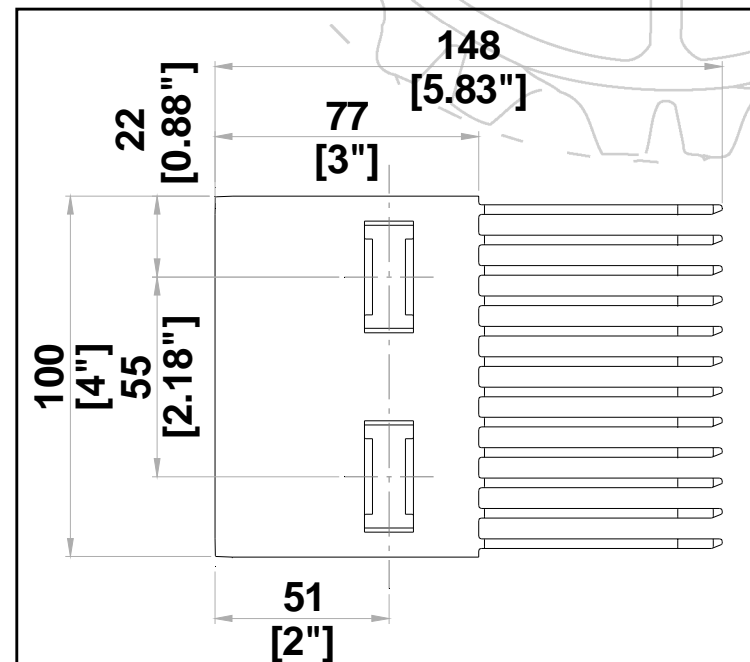

Series 1900

Two material glass handling

- 6"/152mm wide
- 18 fingers
- Mid finger / long back
- grey part is Acetal
- white part is Glass filled polyurethane

Enter separate line item for necessary hardware (consists of 3 bolts, 3 washers and 3 snap caps).

- B4D4MAXXXMT-30 (Metric)
- B4D4IAXXXMT-30 (Imperial)

Part number:

- A4G5R0XXXFNK-10
- Europe Lead time: 30 days
- Stock US

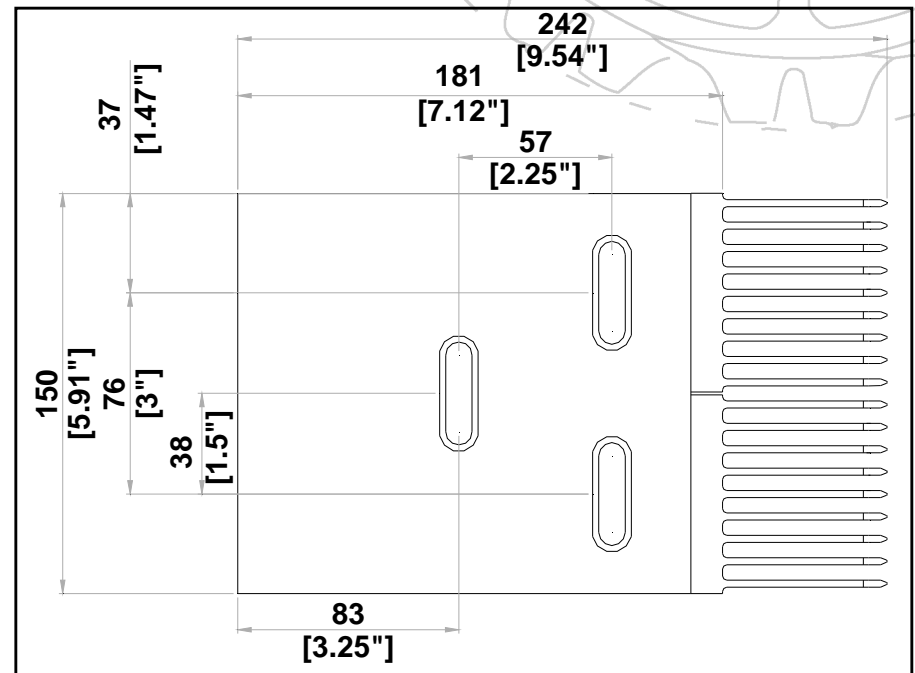

Series 1200/1400/1900

(FTP goes with S1400 6" MTW FLAT TOP SELF-CLEARING EDGE belt but fingers can work also with 1200/1900 RR)

Natural Polyurethane

- Self-clearing
- 6"/152mm wide
- Mid finger

Enter separate line item for necessary hardware (consists of 3 bolts and 3 washers).

- B4XXMBXXXMT-00 (Metric)
- B4XXIBXXXMT-00 (Imperial)

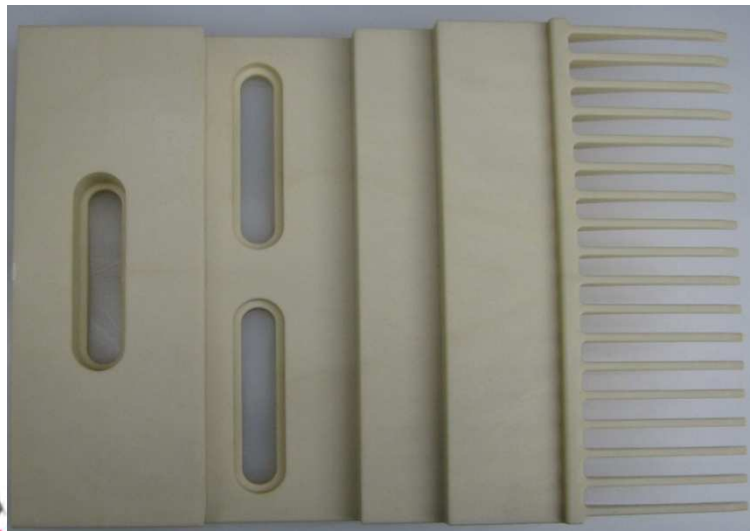

Part number:

- A4XXS6XXXFMI
- Europe Lead time: 30 days
- Stock US

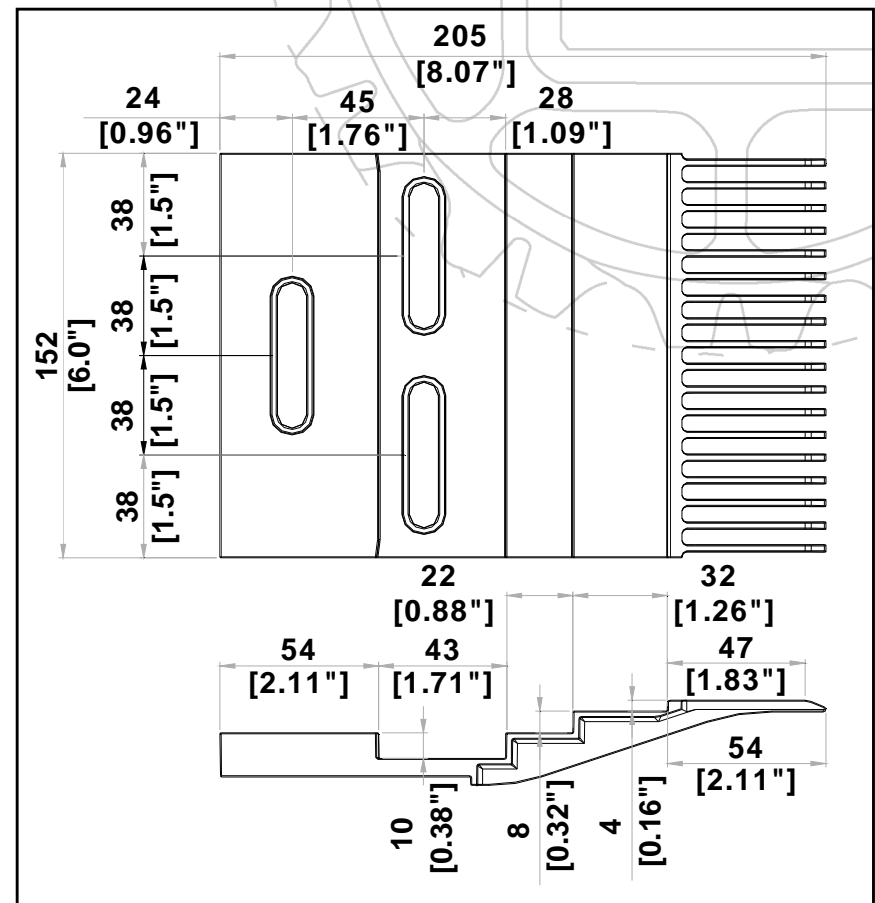

Series 2000 / Intraflex (FOR U.S.)

We don't have the Series 2000 Raised Rib belt anymore in our program. Can only be ordered for replacement.

Grey acetal.

- 6"/152mm wide
- 18 fingers
- 2 nylon shoulder bolts 1/4" included (For Loose parts: Imperial ► A6H7A1XXC3MS-00)
- 2 snap caps included (For loose parts: A7D9XXXXXXLS-01)



Procedure for Orders/quotes:

The Intraflex Series 2000 finger transfer plates are modified from a Series 900 finger transfer plate. The Machine shop machines a second bevel on the tip of the fingers to form a point.

- **Process:** 'Special Inventory Item'
- **Description:** INTRAFLEX GREY ACETAL 6" WIDE FINGERPLATE WITH BOLTS AND SNAP CAPS
- **Work Order Instructions:** Reference Obsolete Part #: A4E3R2XXXFLS-01
- **Price:** \$18.72 each (CY 08)
- **Lead Time:** 10 working days

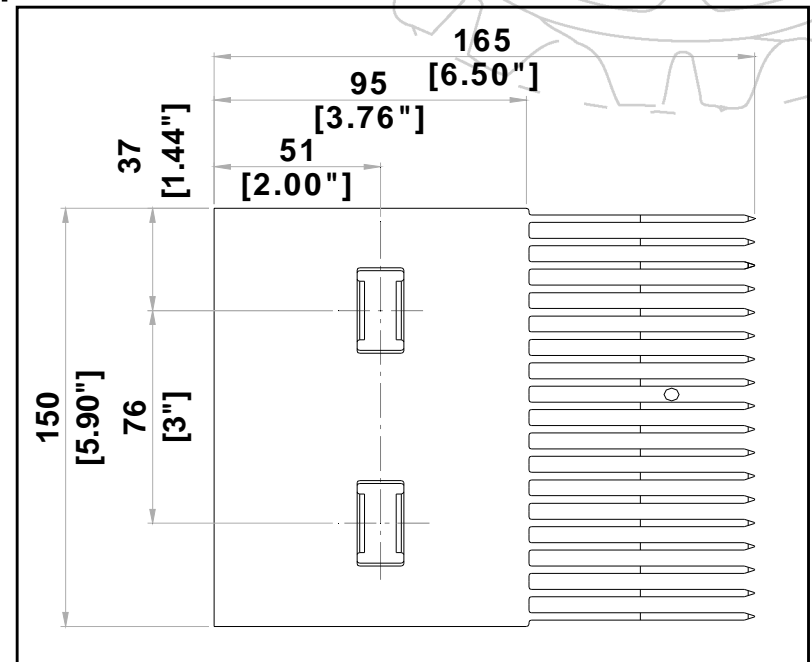

Series 2000 / Intraflex (**FOR EUROPE**)

We don't have the Series 2000 Raised Rib belt anymore in our program. Can only be ordered for replacement.

Grey acetal.

- 6"/152mm wide
- 18 fingers
- 2 nylon shoulder bolts M6 included (For loose parts: Metric ▶ A6H7M1XXT1MG-00)
- 2 snap caps included (For loose parts: A7D9XXXXXXLS-01)



Procedure for Orders/quotes:

The Intraflex Series 2000 finger transfer plates are modified from a Series 900 finger transfer plate. Production machines a second bevel on the tip of the fingers to form a point.

- **Process:** 'Special Inventory Item'
- **Description:** INTRAFLEX GREY ACETAL 6" WIDE FINGERPLATE WITH BOLTS AND SNAP CAPS
- **Work Order Instructions:** Finger Transfer Plates to be modified according sample done by Production
- **Price:** same of S900 FTP A4F4R2XXXFLS
- **Lead Time:** 7 working days

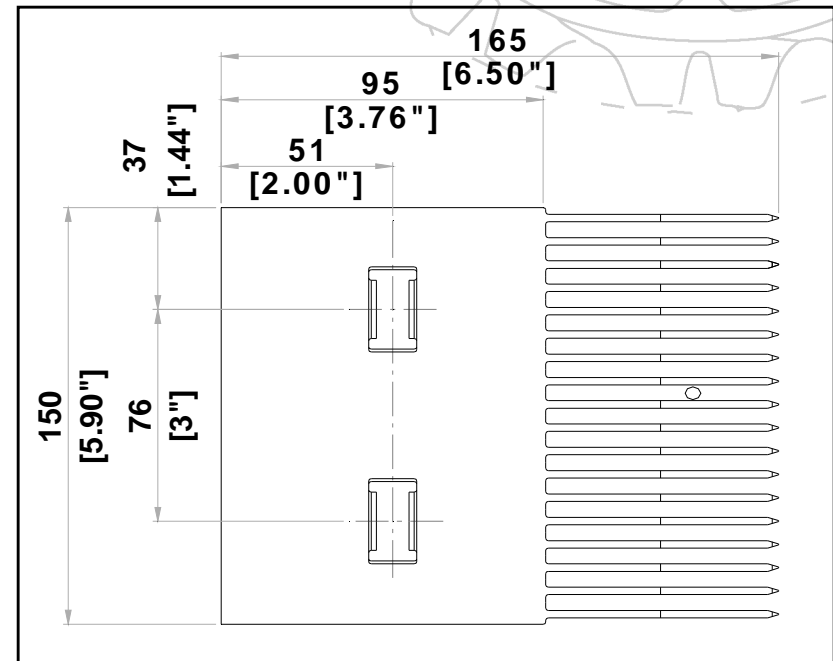

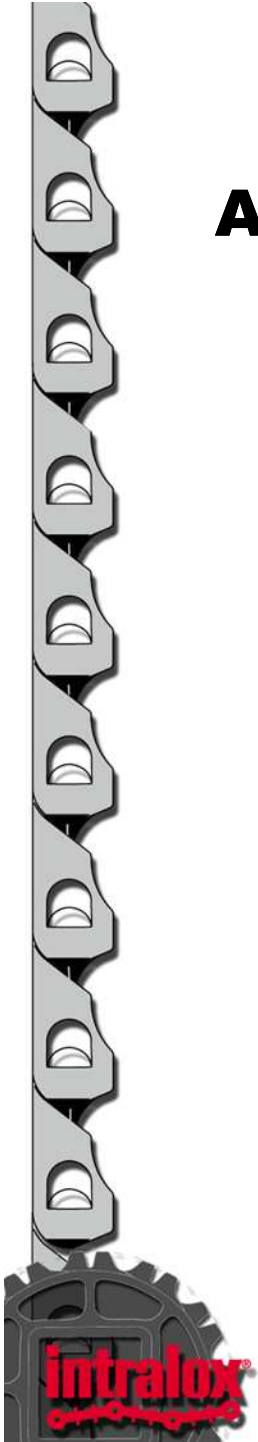

Accessories

- The accessories we have and their part numbers.

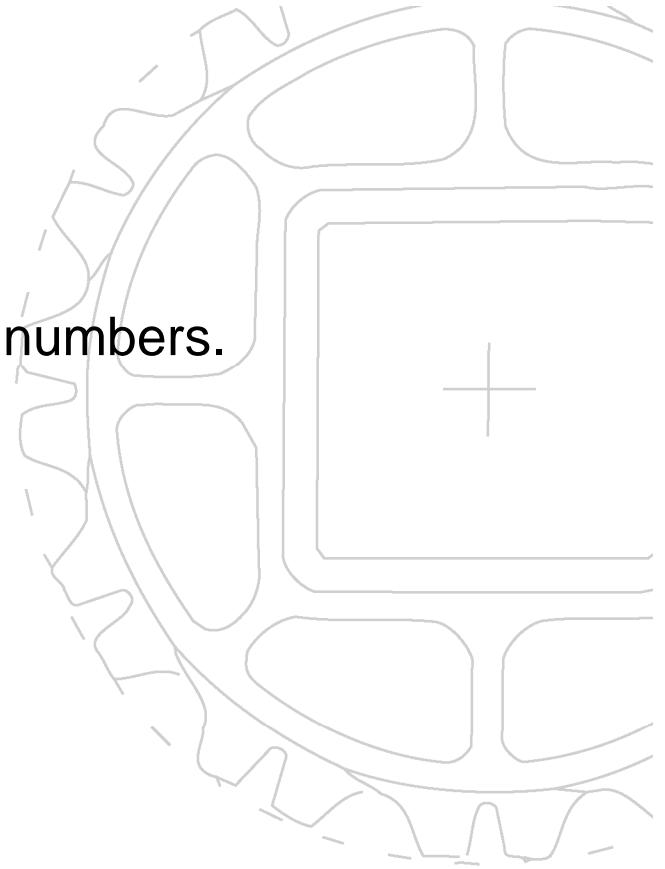

Accessories Cont'd

Nylon Shoulder bolt

- Metric, M6
- Screw head
- Color, White
- per piece

Part number:

- A6H7M1XXT1MG-00
- Stock Europe
- Stock US



Nylon Shoulder bolt

- Imperial, 1/4"
- Screw head
- Color, Grey
- per piece

Part number:

- A6H7A1XXC3MS-00
- Stock Europe
- Stock US

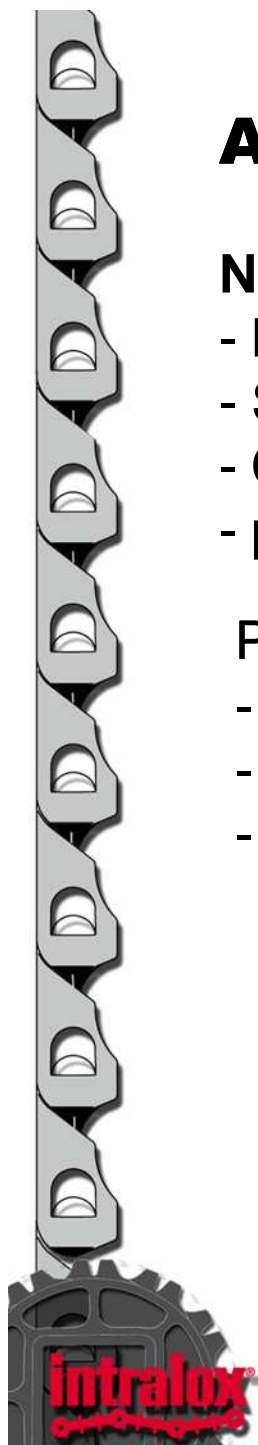
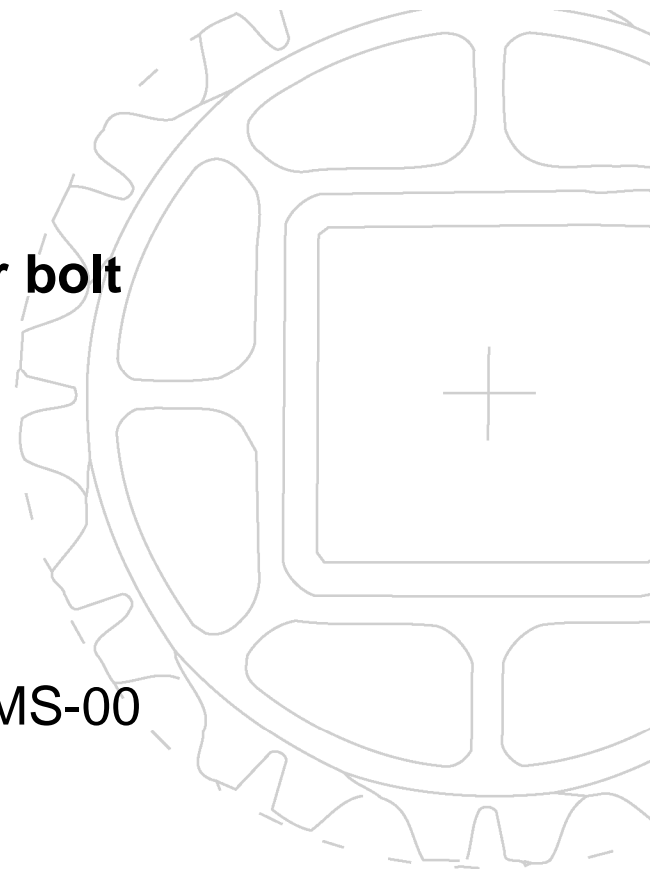

Accessories Cont'd

Snap Cap

- S400/1200
- Right-angled
- Color, Black nylon
- per piece

Part number:

- A7D4XXXXXXMD

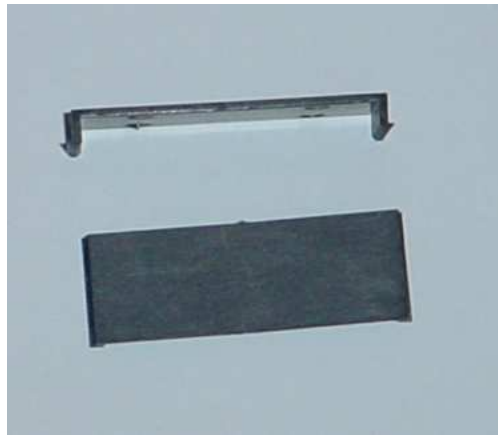

Snap Cap

- S400/1200/800
- Right-angled
- Color, Blue PP
- per piece

Part number:

- A7D4XXXXXXLE-00
- Stock Europe
- Stock US



Snap Cap

- S900/2000
- Right-angled
- Color, Grey acetal
- per piece

Part number:

- A7D9XXXXXXLS-01
- Stock Europe
- Stock US

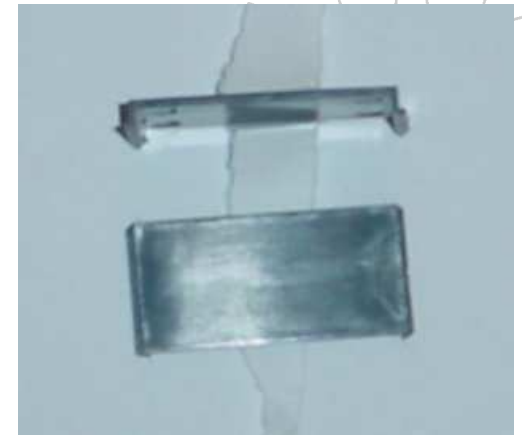

Accessories Cont'd

Snap Cap

- S400/1200/800 Two material
- Oval-shaped
- Color, Grey
- per piece

Part number:

- A7D4BXXXXXLS-01
- Stock Europe
- Stock US



Washer

- S400/1200 Two material
- Oval size
- Stainless Steel
- per piece

Part number:

- B5D43XHXXMT-20
- Stock Europe
- Stock US

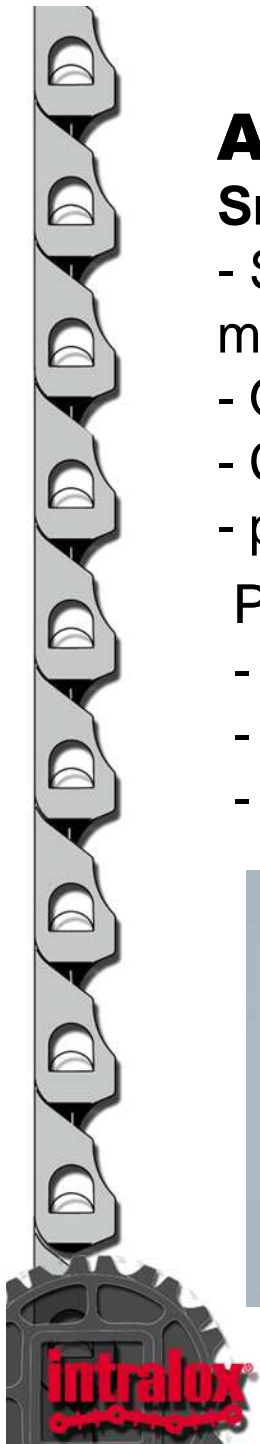
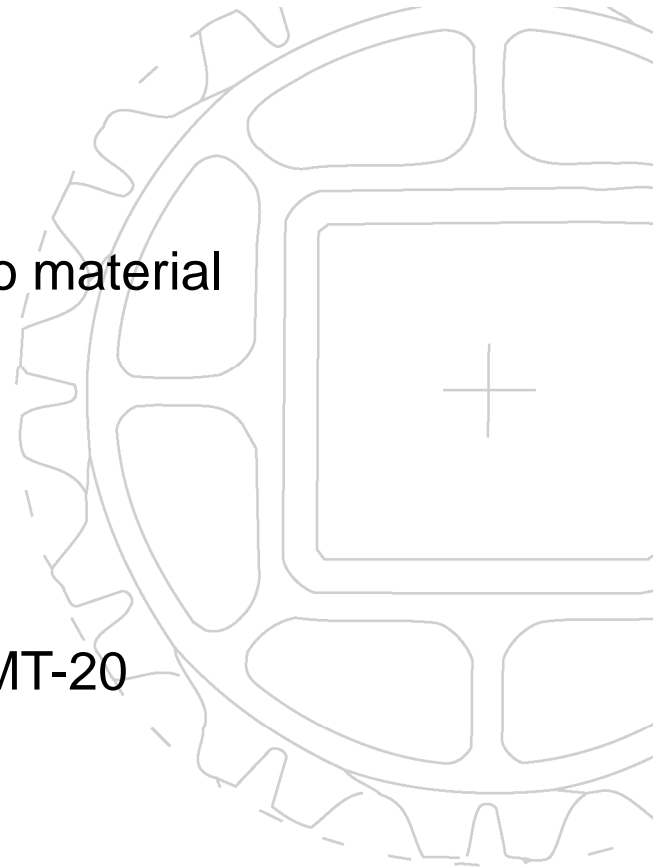

Accessories Cont'd

Stainless Steel (blue metric) bolts

- Metric M6
- Allen head
- per piece

Part number:

- A6H2M1XXT0PM-00
- A6H2M1XXT1PM-00
- Stock Europe
- Stock US

Stainless Steel bolts

- Imperial 1/4"
- Allen head
- per piece

Part number:

- A6H2A1XXT3MT-00
- Europe lead time: 30 days
- Stock US

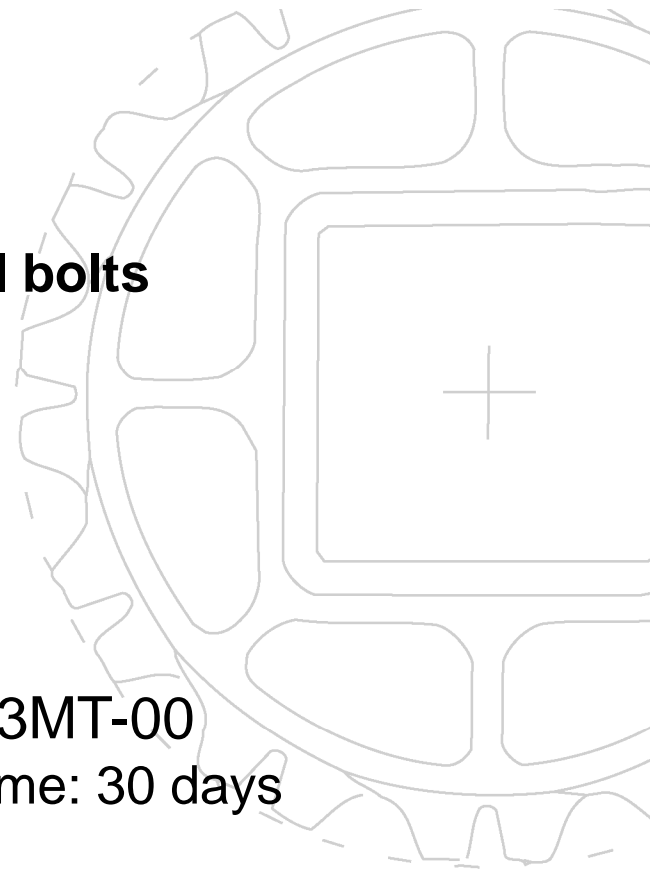
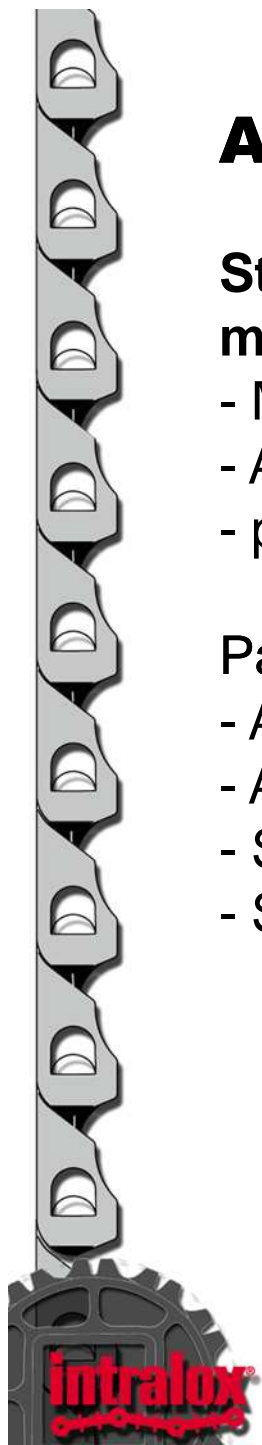

Accessories Cont'd

Snap Cap Set

- S400/1200/1900 Two material
- Metric
- 3 x Oval-shaped snap cap
- 3 x Stainless steel bolts
- 3 x Stainless steel washers

Part number:

- B4D4MAXXXMT-30
- Stock Europe.
- Stock US

Snap Cap Set

- S400/1200 Two material
- Metric
- 2 x Oval-shaped snap cap
- 2 x Stainless steel bolts
- 2 x Stainless steel washers

Part number:

- B4D4MBXXXMT-00
- Stock Europe
- Stock US

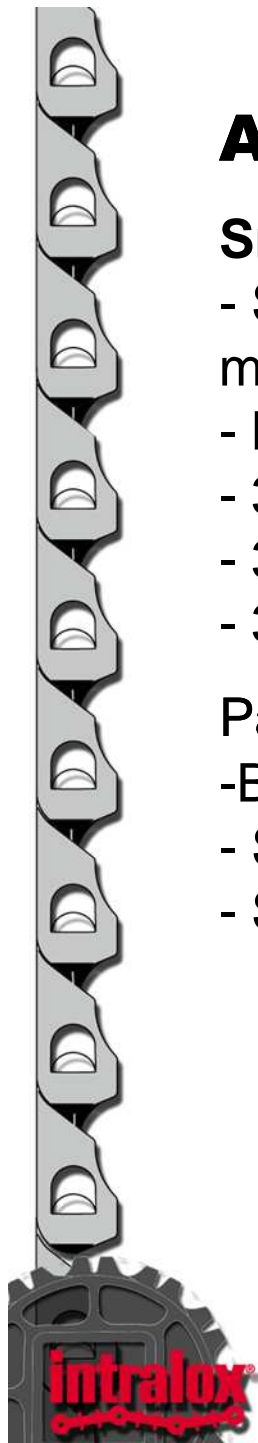
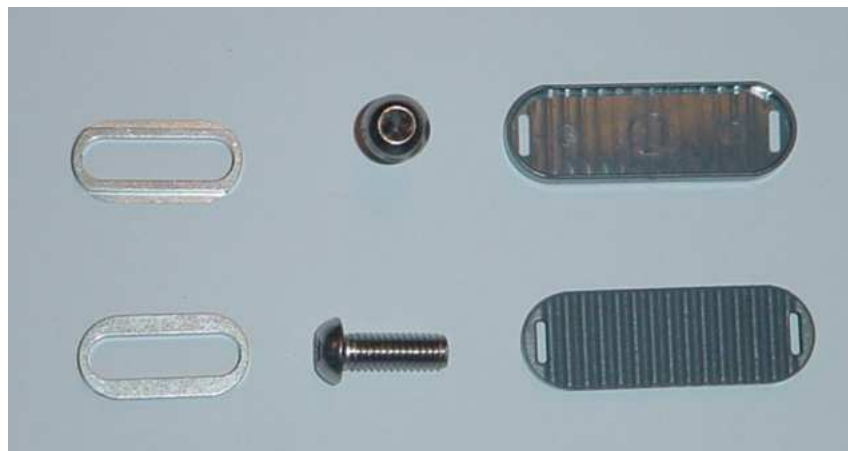

Accessories Cont'd

Snap Cap Set

- S400/1200/1900 Two material
- Imperial
- 3 x Oval-shaped snap cap
- 3 x Stainless steel bolts
- 3 x Stainless steel washers

Part number:

- B4D4IAXXXMT-30
- Europe lead time: 30 days
- Stock US

Snap Cap Set

- S400/1200 Two material
- Imperial
- 2 x Oval-shaped snap cap
- 2 x Stainless steel bolts
- 2 x Stainless steel washers

Part number:

- B4D4IBXXXMT-00
- Europe lead time: 30 days
- Stock US

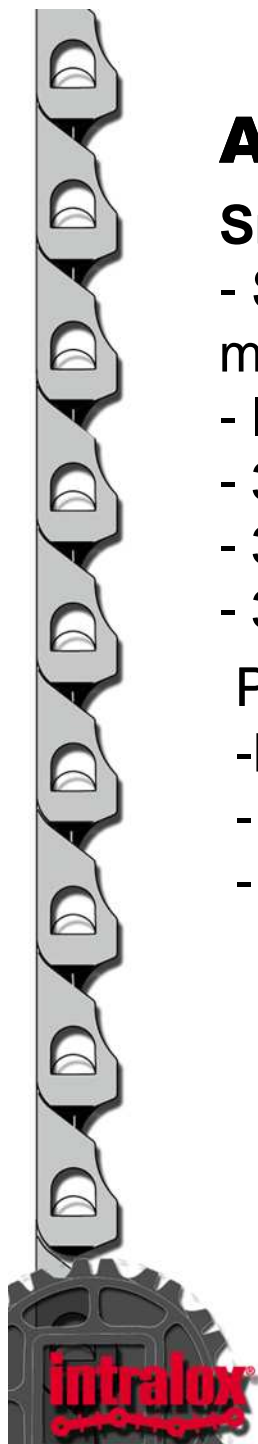
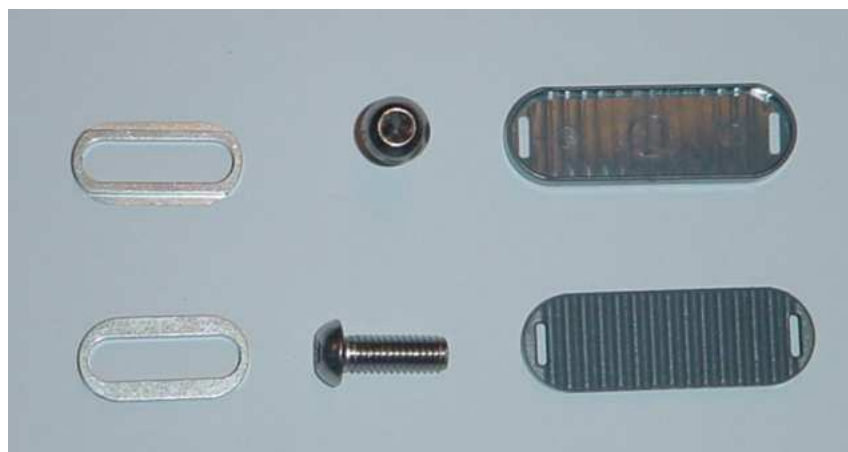

Accessories Cont'd

Hardware Set

- S400/1200/1400/1900
- Imperial
- 3 x Stainless steel bolts
- 3 x Stainless steel washers
- No snap caps needed

Part number:

- B4XXIBXXXMT-00
- Europe lead time: 30 days
- Stock US

